

Centre Number	Candidate Number	Name
---------------	------------------	------

UNIVERSITY OF CAMBRIDGE INTERNATIONAL EXAMINATIONS
General Certificate of Education Ordinary Level

PHYSICS

5054/04

Paper 4 Alternative to Practical

October/November 2004

1 hour

Candidates answer on the Question Paper.
No Additional Materials are required.

READ THESE INSTRUCTIONS FIRST

Write your Centre number, candidate number and name on all the work you hand in.
Write in dark blue or black pen in the spaces provided on the Question Paper.
You may use a soft pencil for any diagrams, graphs or rough working.
Do not use staples, paper clips, highlighters, glue or correction fluid.

Answer **all** questions.

At the end of the examination, fasten all your work securely together.

The number of marks is given in brackets [] at the end of each question or part question.

If you have been given a label, look at the details. If any details are incorrect or missing, please fill in your correct details in the space given at the top of this page.

Stick your personal label here, if provided.

For Examiner's Use	
1	
2	
3	
4	
5	
Total	

This document consists of **11** printed pages and **1** blank page.



- 1 The apparatus shown in Fig. 1.1 is to be used to determine a value for the average diameter of the wire on the reel.

reel of thin wire

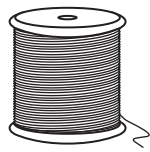

Plasticine



metre rule graduated in millimetres

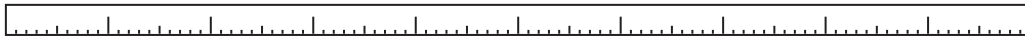

Fig. 1.1

The wire is flexible and its average diameter d is about 0.8 mm.

Describe how you would use the apparatus to obtain an accurate value for d . In your answer, you should

- state the procedure you would use,
- state what measurements you would make,
- explain how you would make the measurements to obtain an accurate value for d ,
- show how you would calculate the value of d ,
- explain why your method gives an average value for d .

You may write on page 3 and you may draw diagrams if you wish.

[6]

- 2 The resistance R of a thermistor changes with temperature. The apparatus and the circuit that are used to determine R are shown in Fig. 2.1.

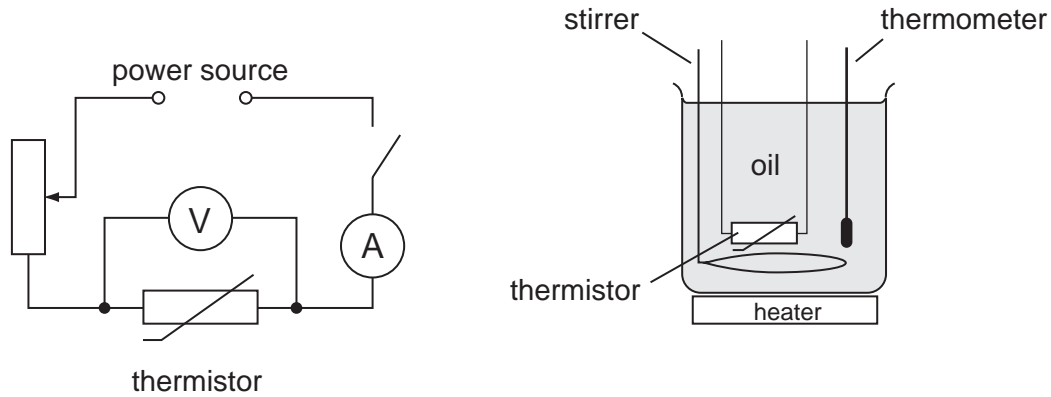

Fig. 2.1

The thermistor is immersed in oil. The resistance R is determined for various values of the temperature θ of the oil. The value of R is calculated using the equation $R = V/I$.

- (a) In the space below, draw up a table in which all the required readings may be recorded, together with the values for R . Assume that five sets of readings are taken. [3]

(b) State two precautions you would take in order to obtain the most accurate readings.

1.

.....

2.

.....[2]

(c) Suggest a reason why the thermistor is immersed in oil and **not** in water.

.....

.....[1]

- 3 Acetophenone is a liquid at 19 °C but it becomes a solid at a temperature between 1 °C and 16 °C.

You are to determine the temperature at which acetophenone becomes a solid. The apparatus given to you is shown in Fig. 3.1. Some liquid acetophenone is to be cooled in a test-tube by immersing the test-tube in mixture of ice and water.

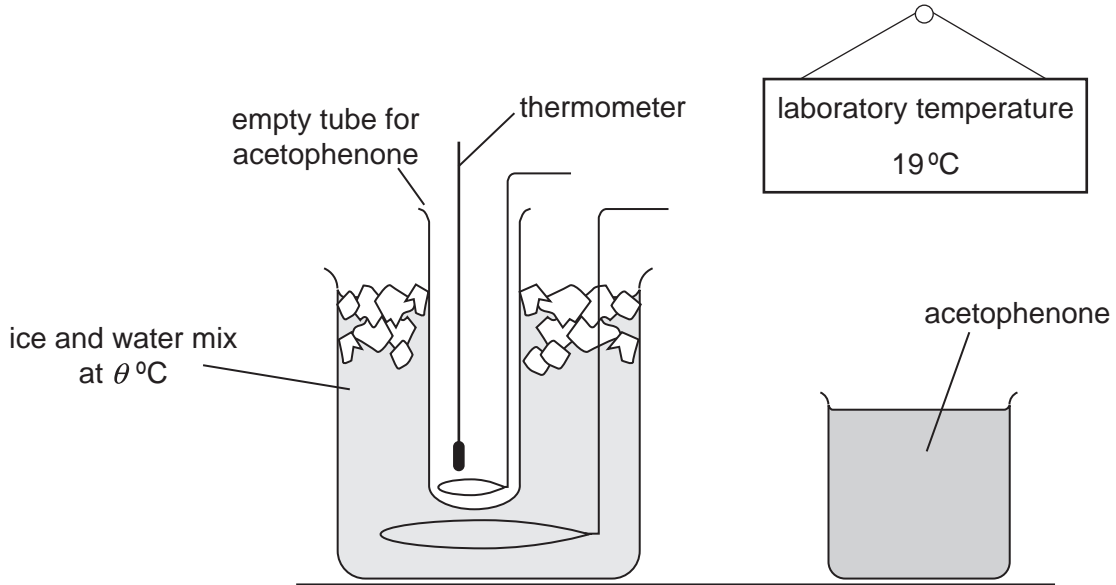

Fig. 3.1

- (a) On Fig. 3.1, the temperature of the ice and water mixture is given as θ °C. What is the value for the temperature θ °C? Explain your answer.

.....

[2]

- (b) (i) In Fig. 3.1, the test-tube is shown to be empty. You can choose the amount of acetophenone to use in the experiment. On Fig. 3.1, draw a line in the empty test-tube to represent the surface of the acetophenone.

- (ii) Give two reasons why you chose the amount you have indicated on Fig. 3.1.

1.

 2.

[3]

- (c) You are working with another member of the class. She suggests that you should plot a graph of temperature against time in order to determine the temperature θ_s at which the acetophenone becomes a solid.

Fig. 3.2 shows some of the readings plotted on a graph grid. Use the graph to obtain a value for θ_s .

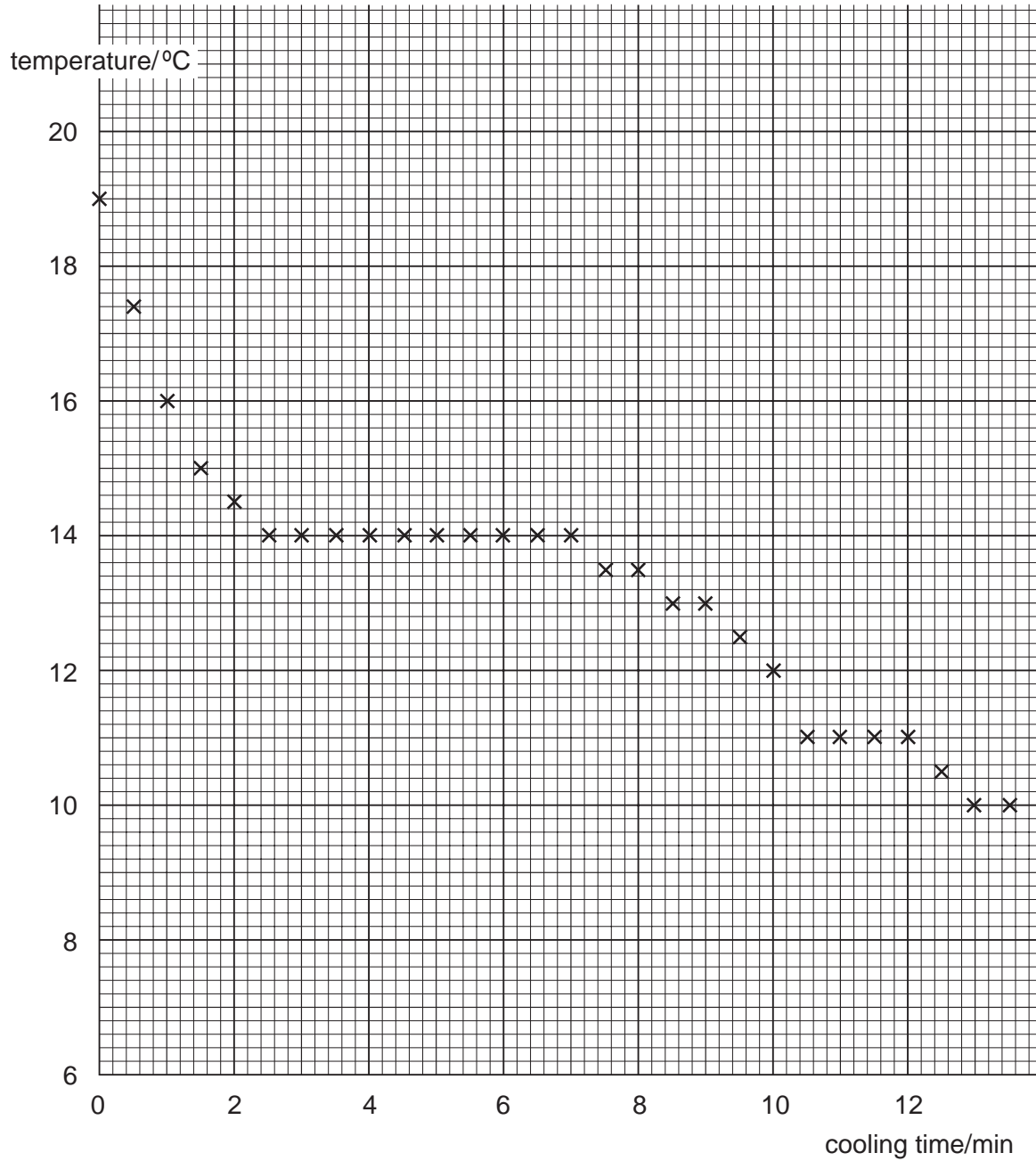

Fig. 3.2

$\theta_s = \dots\dots\dots$ [1]

4 In a light experiment, a ray of light is incident on one face of a triangular glass prism. The path of the incident ray and the path of the emergent ray are marked with small dots P_1 , P_2 , P_3 and P_4 , as shown in Fig. 4.1.

(a) On Fig. 4.1, draw neat lines to represent the incident and emergent rays. Make the two lines long enough so that they cross. Measure the angle between the incident ray and the emergent ray.

angle = [3]

(b) The ray of light passes through the glass. On Fig. 4.1, draw the path of the refracted ray inside the glass. [1]

(c) In order to view an object, the normal eye needs to be at least 25 cm away from the object. On Fig. 4.1 the object is labelled O. Fig. 4.1 is a full-size diagram.

On Fig. 4.1, mark with the letter **E** the position where you would place your eye in order to see the object O through the prism. [1]

(d) On Fig. 4.1, draw the angle of incidence at the surface of the prism nearest to the object O. Label the angle i . [1]

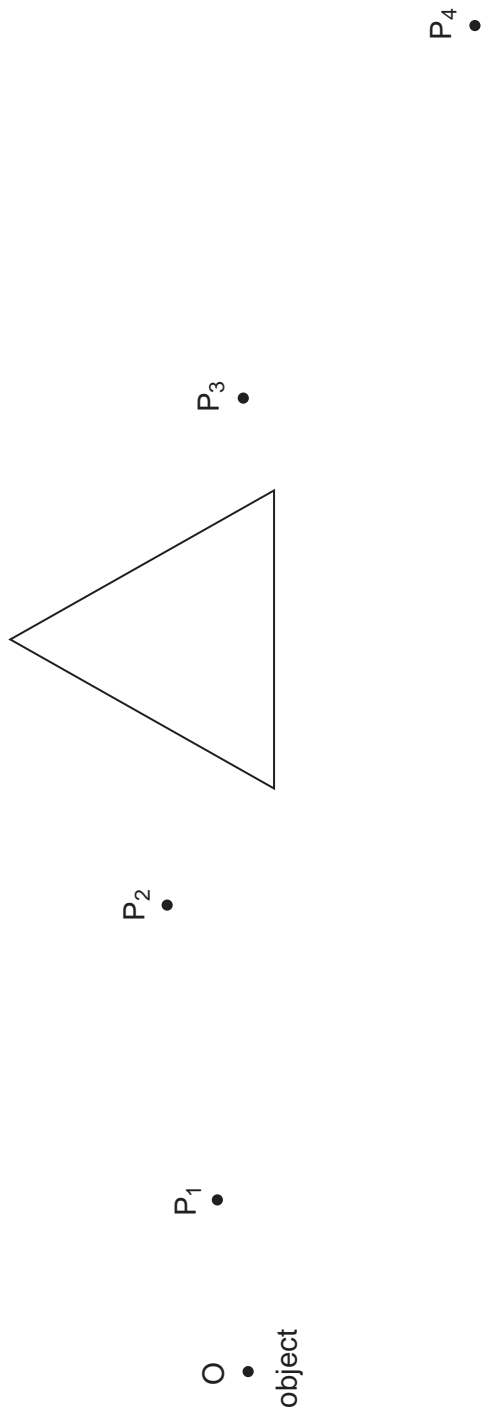

Fig. 4.1

- 5 A converging lens is used as a magnifying glass. A well-lit scale on a rule is observed through the lens, as shown in Fig. 5.1.

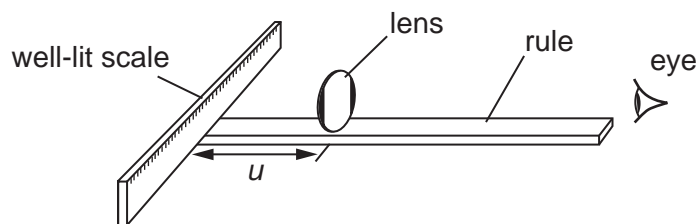

Fig. 5.1

Two labels stuck to the sides of the lens restrict the field of view through the lens. A magnified image of a small part of the scale is observed, as shown in Fig. 5.2. The length w of the scale seen through the lens is recorded. The object distance u is also recorded.

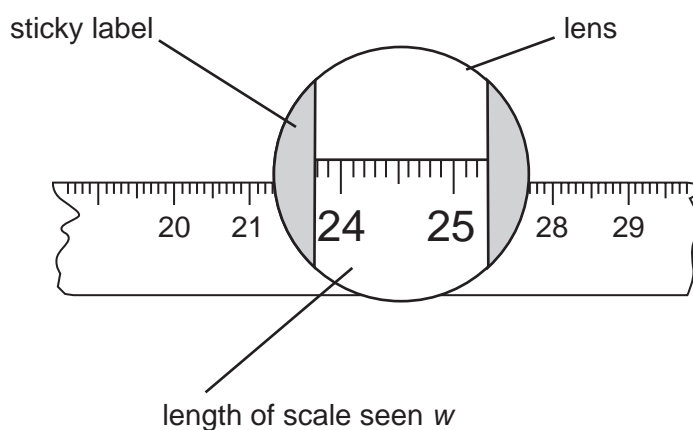

Fig. 5.2

The procedure is repeated for different values of u and the values obtained are given in Fig. 5.3.

object distance u/mm	19	39	78	82	108	148
length of scale seen w/mm	42	37	30	29	26	21

Fig. 5.3

- (a) Plot the graph of w/mm (y -axis) against u/mm (x -axis). Draw the best smooth curve through the graph plots. [4]

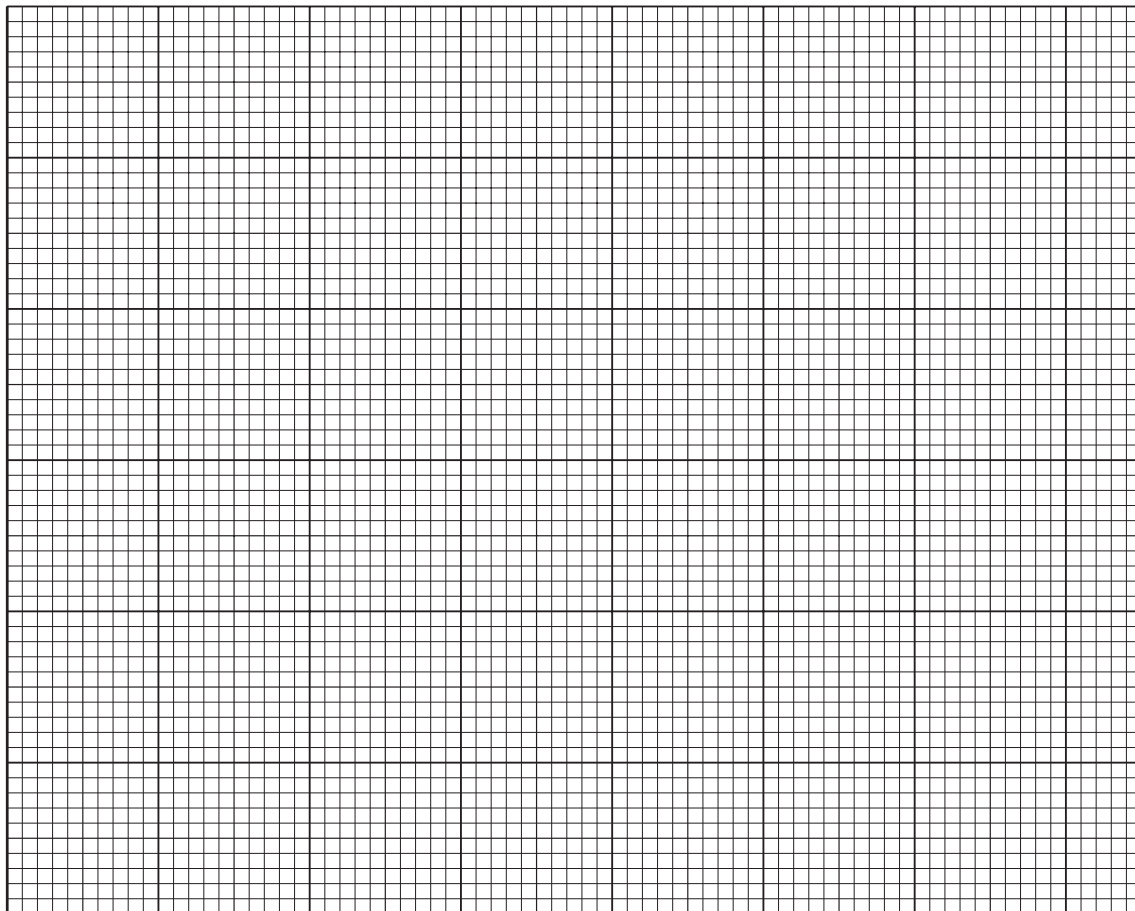

- (b) State how the readings show that the magnification of the scale is greatest for the last set of values, [148, 21]. You may draw a diagram if you wish.

.....

[1]

- (c) Describe how the magnification of the image of the scale changes as the value of u is increased.

.....
[1]

Every reasonable effort has been made to trace all copyright holders where the publishers (i.e. UCLES) are aware that third-party material has been reproduced. The publishers would be pleased to hear from anyone whose rights they have unwittingly infringed.

University of Cambridge International Examinations is part of the University of Cambridge Local Examinations Syndicate (UCLES), which is itself a department of the University of Cambridge.